

**SPECIFICATION  
FOR  
SWITCHING POWER SUPPLY**

**M/N: MPM-S125(-SB)**

**Revision History**

Version	Date	Change Items
Rev. 1.0	June.16. 2017	Established.

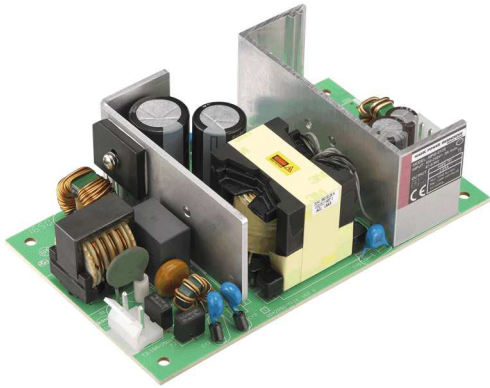

## FEATURES

- ✓ 120W single fanless output, optional 5Vsb ON/OFF and PG / PF function with –SB model.
- ✓ Max. 135W with 13.6 CFM force air-cooling
- ✓ Designed to meet IEC 60601-1-2 4th ed. EMC
- ✓ Designed to meet medical standard EN / UL 60601-1 3.1 Edition
- ✓ Class II design, can be used for homecare equipment.
- ✓ Meets EMI CISPR/FCC class B without any metal plate shielding.
- ✓ 2 x MOPP
- ✓ No load power consumption is less than 0.3W at input 115VAC

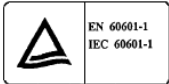

# CB

## Models & Ratings

Model Number	Wattage (Rated / Max)	Output Voltage		Min. Current	Rated Current	Max. Current
MPM-S125	120 W / 135W	V1	+24 V	0 A	5 A	5.6 A
MPM-S125-SB	120 W/ 135W	V1	+24 V	0 A	5 A	5.6 A
		V2	+5 V	0 A	0.5 A	0.5 A

Note:  
**Total Output Power:** Max. 120W convection cooled, above 121~135W with 13.6 CFM forced air-cooling at 50°C environment temperature.  
 Please see detail performance curves as below.

## Summary

Characteristic	Minimum	Typical	Maximum	Units	Notes & Conditions
Input Range	85	115 / 230	264	VAC	Universal input range
Input Frequency	47	50 / 60	63	Hz	AC input
Efficiency		90		%	At input 230VAC, rated load, 1.0 hr. warm up.
Operation Temperature	-20		+70	°C	Derate linearly from 50°C, become 50% load at 70°C
Weight		270		g	-SB model is 280g.
Dimensions	127 (L) x 76.2 (W) x 40.7 (H) mm, Tolerance +/- 0.5mm.				
EMC	EN 55011, EN 60601-1-2, EN 61000-3-2, EN 61000-3-3, IEC 61000-4-2, IEC 61000-4-3, IEC 61000-4-4, IEC 61000-4-5, IEC 61000-4-6, IEC 61000-4-8, IEC 61000-4-11				
Safety Approvals	IEC 60601-1, EN 60601-1				

## Input

Characteristic	Minimum	Typical	Maximum	Units	Notes & Conditions
Input Voltage	85	115 / 230	264	VAC	Universal input range
Input Frequency	47	50 / 60	63	Hz	AC input
Input Current			3.0 / 1.5	A	Nominal AC Input Voltage (115VAC/230VAC), rated load.
Inrush Current			30 / 60	A	Nominal AC Input Voltage (115VAC/230VAC), one cycle at 25°C cold start.
Leakage Current		100/300		μA	Normal Condition / Single Fault Condition
No-load power consumption		0.3 / 0.5		W	Nominal AC Input Voltage (115VAC/230VAC). Only with model MPM-S125.
Input Protection	Dual non-user serviceable internally located AC input line fuse. Fuse : 3.15A / 250VAC * 2pcs				

## Output

Characteristic	Minimum	Typical	Maximum	Units	Notes & Conditions
Output Voltage		24		VDC	
		5			
Initial Set Accuracy (Note 1)		±1		%	
Minimum Load		0		A	
Start Up Delay		1.5 / 1.0		Sec.	Time required for initial output voltage stabilization. Nominal AC Input Voltage (115VAC/230VAC), rated load at 25°C.
Hold Up Time	12 / 50	16 / 70		mS	Nominal AC Input Voltage (115VAC/230VAC), rated load.
Line Regulation		±0.5 <sup>(V1)</sup> ±0.5 <sup>(V2)</sup>		%	Less than ±1% at rated load with ±10% changing in input voltage.
Load Regulation		±0.5 <sup>(V1)</sup> ±0.5 <sup>(V2)</sup>		%	Measured from 60% to 100% rated load and from 60% to 20% rated load (60% ±40% rated load).
Ripple & Noise (Note 2)		240 <sup>(V1)</sup> 50 <sup>(V2)</sup>		mV	Rated load, 20MHz bandwidth
Oversoltage Protection	For some reason the power supply fails to control itself, the build-in over voltage protection circuit will shut down the outputs to prevent damaging external circuits.				
Overload Protection	Auto recovery				
Short Circuit Protection	Fully protected against output overload and short circuit. Automatic recovery upon of overload condition.				
Remote On / Off	Only with model MPM-S125-SB.				
Remote Sense	N/A				

### Note:

1. Initial setting accuracy is adjusted at input 115VAC and output at 60% rated load.
2. Measured by a 20MHz bandwidth limited oscilloscope and each output is connected with a 10μF Electrolytic Capacitor and a 0.1μF Ceramic Capacitor.

## General

Characteristic	Minimum	Typical	Maximum	Units	Notes & Conditions
Efficiency		90		%	At input 230VAC, rated load, 1.0 hr. warm up.
Isolation	IP to OP	4000		VAC	2xMOPP
	IP to Ground	1500		VAC	2xMOPP (Screw head to primary)
Switching Frequency		<65		KHZ	
MTBF		680,000		hrs.	MIL-HDBK-217F at 25°C
Power Good Signal (Only with -SB model)	When power is turned on, the power good signal will go high 100 mS to 500 mS after all output DC voltages are within regulation limits.				
Power Fail Signal (Only with -SB model)	The power fail signal will go low at least 1 mS before any of the output voltages fall below the regulation limits.				

## Environmental

Characteristic	Minimum	Typical	Maximum	Units	Notes & Conditions
Low temperature start up	-30			°C	Some specification parameters maybe exceeded until after 20 minutes warm up period. (Note 1)
Operating Temperature	-20		+70	°C	Derate linearly above 50°C, performance curves will be provided after testing.
Storage Temperature	-40		+85	°C	
Relative Humidity	5		95	%RH	Non-condensing.
Cooling	13.6			CFM	Forced-cooled > 120W
Operating Altitude		5000		m	
Vibration	0.26		6.09	G	Frequency Type: Sweep Frequency Frequency Range: 10~55 Hz Displacement: 1.0mm Sweep Rate: 60 minute / cycle Number of cycle: 1 cycle / axis Direction: X , Y and Z axis

Note:  
1. To start up at low temperature, when the  $V_{IP} < 115VAC$ , please set the rated load @ 10% for maximum; when  $115VAC < V_{IP} < 230VAC$ , please set the rated load @ 30% for maximum; when  $V_{IP} \geq 230VAC$ , there will be no specific limitation on rated load setting.

## Derating curve

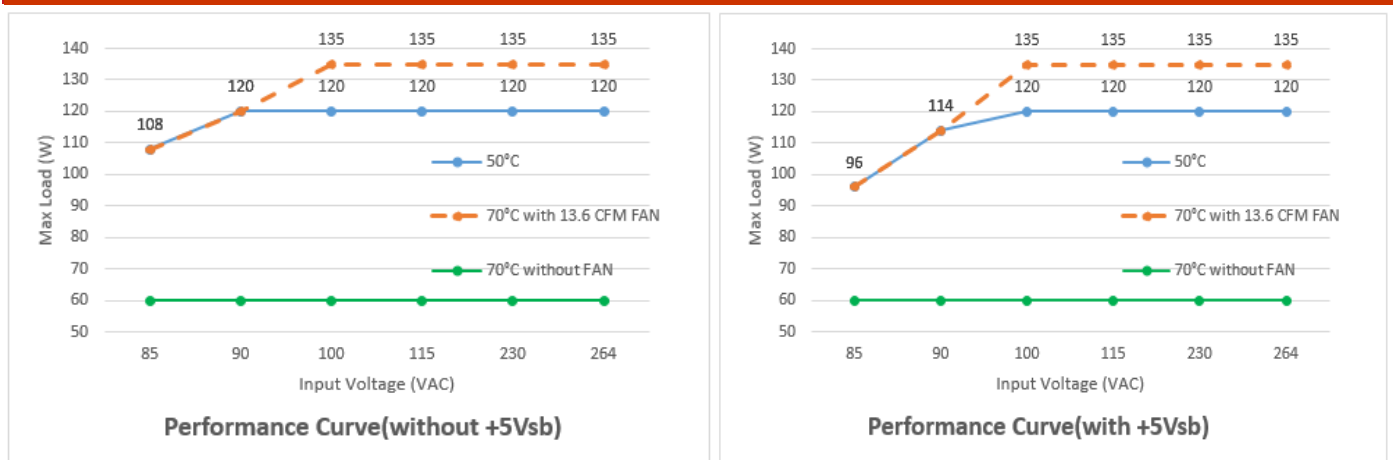

## EMC: Emissions

Phenomenon	Standard	Class	Notes & Conditions
Conducted	EN 55011 / CISPR 11 & FCC Part 18	B	1. Pass without enclosure. 2. Pass with or without a metal plate below the power supply.
Radiated	EN 55011 / CISPR 11 & FCC Part 18	B	
Harmonic Current	EN 61000-3-2	A	
Voltage Flicker	EN 61000-3-3		

Note:

- Above specification is applied with output equal or below 120W. For higher output power, please re-confirm with us.
- Above specification is based on the test conditions of EN 55011 / CISPR 11 & FCC Part 18. If there is any question when the power supply is applied to the system, please contact us for assistance.

## EMC: Immunity

Phenomenon	Standard	Criteria	Notes & Conditions
ESD	IEC 61000-4-2	A	±15KV air discharge, ±8KV contact discharge
Radiated	IEC 61000-4-3	A	10V/m
EFT	IEC 61000-4-4	A	±2KV Line & PE, 100KHz
Surges	IEC 61000-4-5	A	L-N:±1KV, L/N-PE:±2KV
Conducted	IEC 61000-4-6	A	10V
Power Magnetic	IEC 61000-4-8	A	30A/m
Dips and Interruptions	IEC 61000-4-11	A A / B A / B B	DIP: >95%, 0.5 cycle DIP: 30%, 25 cycles (Note 2.) DIP: 60%, 5 cycles (Note 2.) INT: >95%, 250 cycles

Note:

- Above specification is applied with output equal or below 120W. For higher output power, please re-confirm with us.
- The test result of input 240Vac / 100Vac is criteria A / B.

## Safety Approvals

Safety Agency	Safety Standard	Notes & Conditions
TUV	EN 60601-1: 2006+A11+A1+A12	Approved (Medical 3.1 <sup>rd</sup> )
CB	IEC 60601-1: 2005+CORR. 1: 2006+CORR. 2: 2007+A1: 2012	
UL/cUL	ANSI/AAMI ES60601-1, CAN/CSA-C22. 2 No. 60601-1	Designed to meet (Medical 3.1 <sup>rd</sup> )

## Mechanical Details

SIZE : 127.0(L) x 76.2(W) x 40.7(H)mm, Tolerance +/-0.5mm.

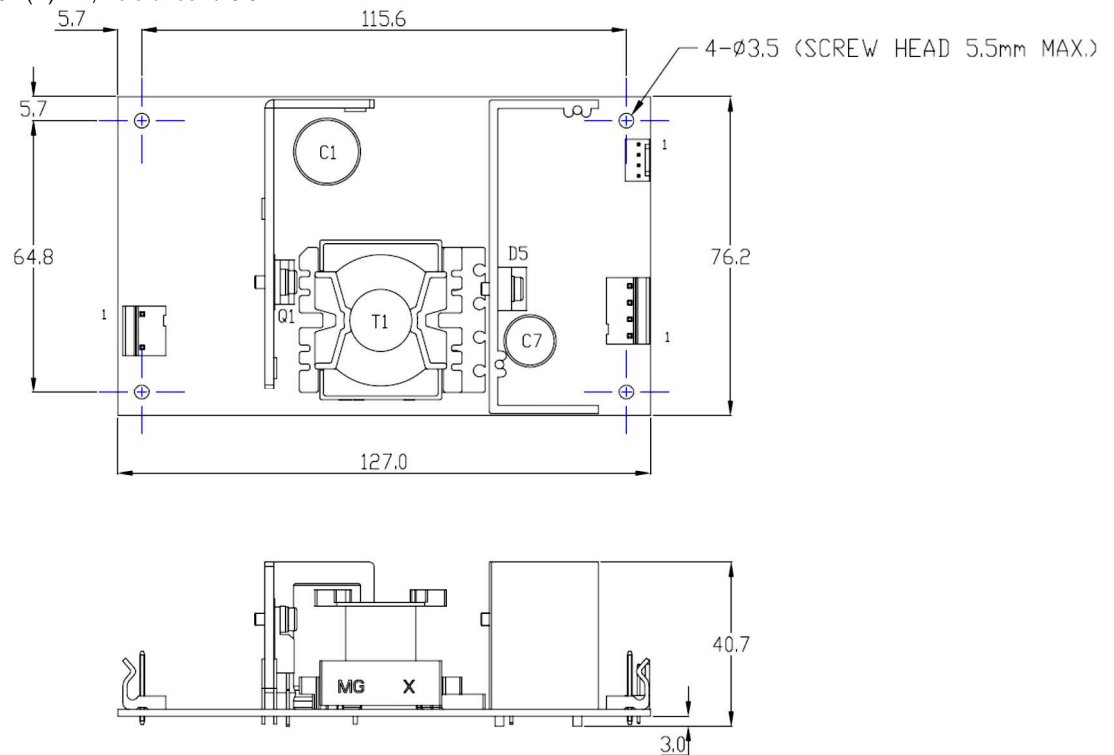

Input Connector CN1	
Pin 1	Line
Pin 2	Empty
Pin 3	Neutral

Mates with Molex 09-50-1031 and Molex series 5194 crimp terminals or Equivalent.

When used model no. suffixed -J mates with JST VHR-3N and JST series SVH-21T-P1.1 crimp terminals or Equivalent.

Output Connector CN2	
Pin 1	+V
Pin 2	+V
Pin 3	GND
Pin 4	GND

Mates with Molex 09-50-1041 and Molex series 5194 crimp terminals or Equivalent.

When used model no. suffixed -J mates with JST VHR-4N and JST series SVH-21T-P1.1 crimp terminals or Equivalent.

Signal Connector CN3	
Pin 1	+5Vsb
Pin 2	GND
Pin 3	ON/OFF
Pin 4	PG/PF

\*Optional

Mates with Molex 22-01-1042 and Molex series 2759 crimp terminals or Equivalent.

When used model no. suffixed -J mates with JST XHP-4 and JST series SXH-001T-P0.6N or SXH-001T-P0.6 or SXH-002T-P0.6 crimp terminals or Equivalent.

## Performance

(Input voltage: 115Vac)

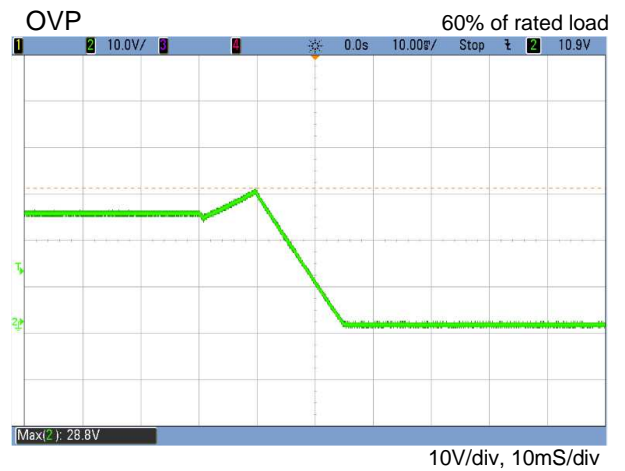
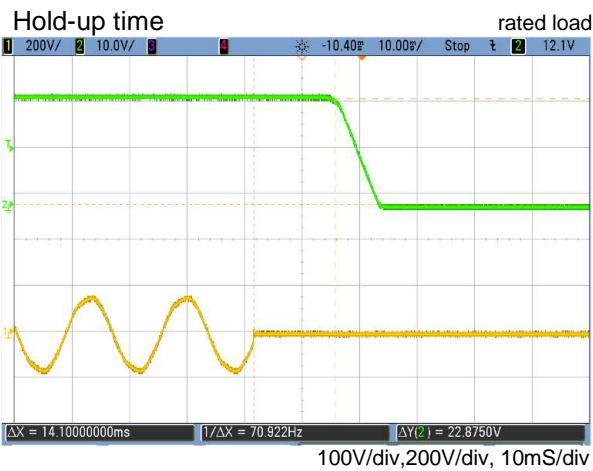
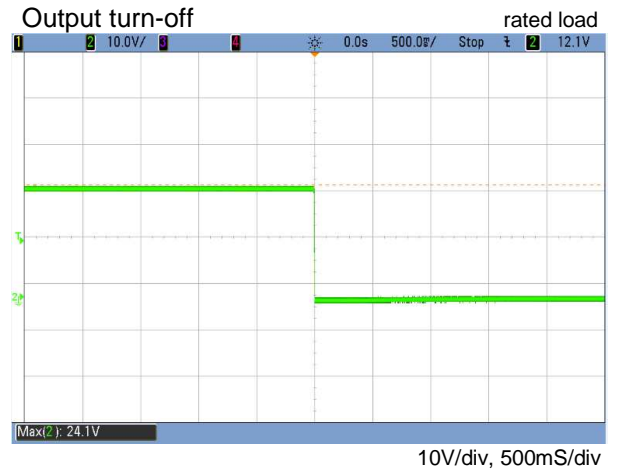
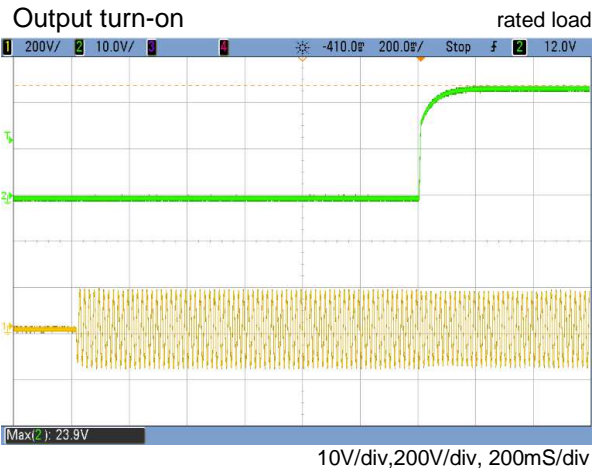
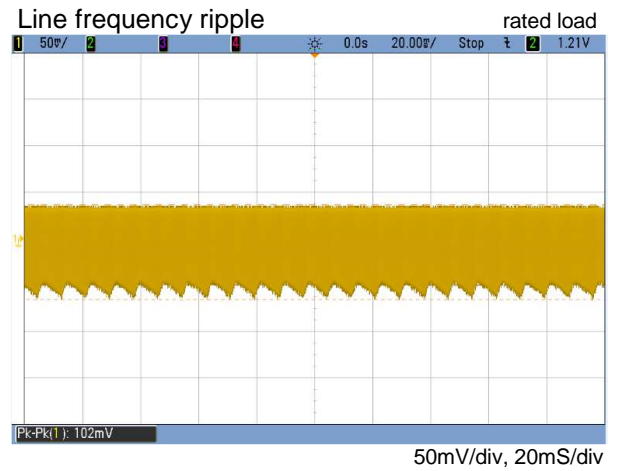
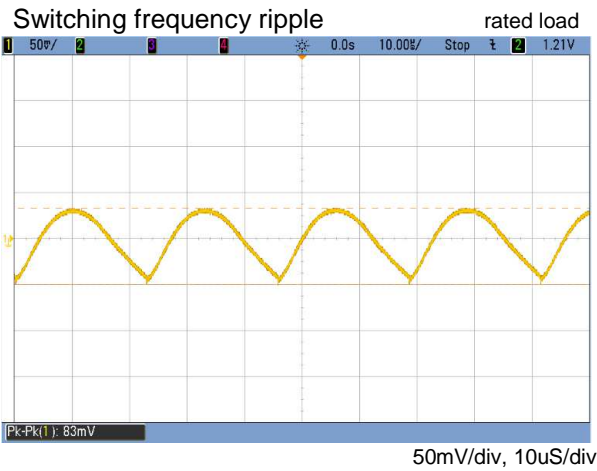

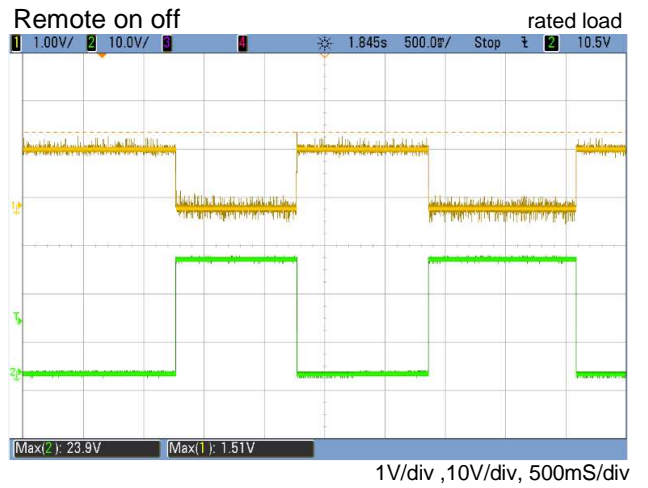
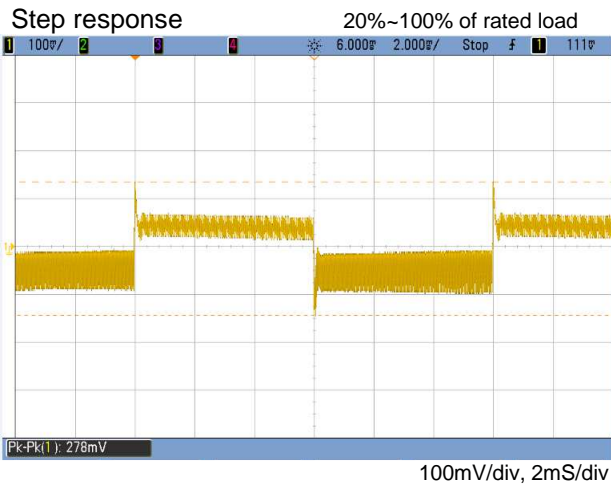
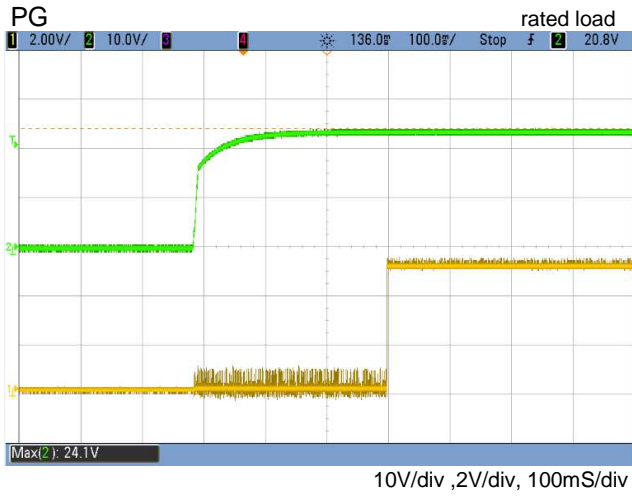



EMI: EN55011 "B" (Conduction)

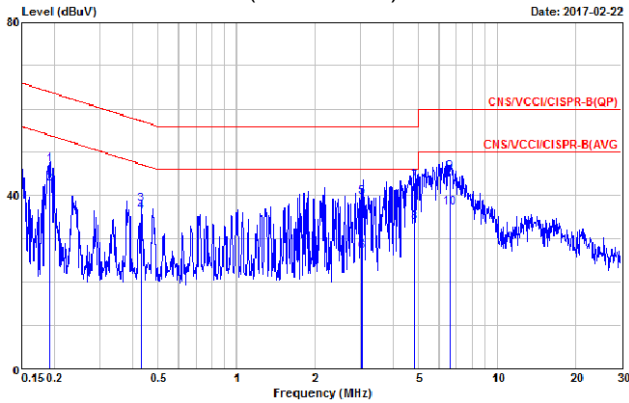

230Vac/rated load

EMI: FCC "B" (Conduction)

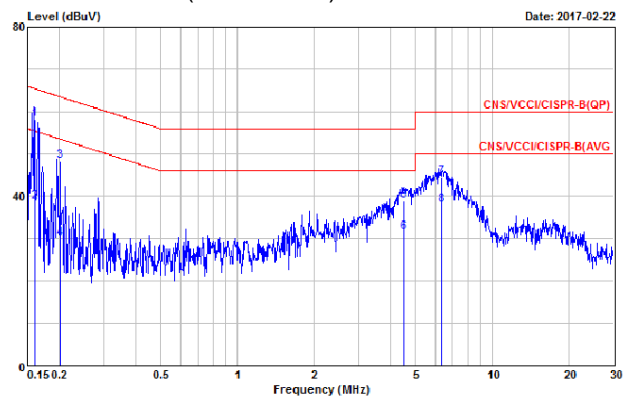

115Vac/rated load

EMI: EN55011 "B" (Radiation)

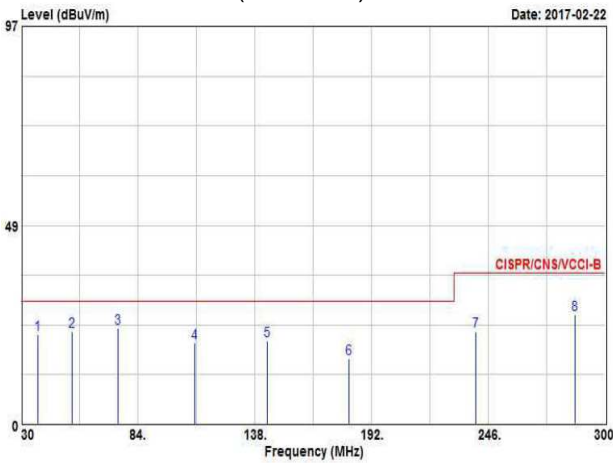

230Vac/rated load

EMI: FCC "B" (Radiation)

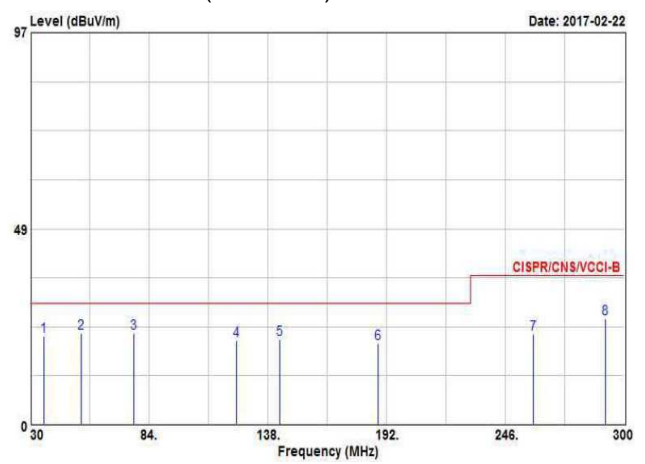

115Vac/rated load

## Thermal Considerations

In order to ensure safe operation of the SPS in the end-use equipment, the temperature of the components listed in the table below must not be exceeded.

Temperature should be monitored using J type thermocouples placed on the hottest part of the component (out of any direct air flow). See mechanical details for component locations.

Temperature measurements at max. amb.

Component	Max Temperature
T1	110°C
Q1	120°C
D5	120°C
C1	105°C
C7	105°C